

A Wealth of Models for All Types of Applications

- Easy installation, high-speed pulse generator, high-speed rotation control, and more.
- Direct mounted to metal (-N Models).
- A wealth of models ideal for limit control, counting control, and other applications (-N Models).



For the most recent information on models that have been certified for safety standards, refer to your OMRON website.

Ordering Information

Sensors [Refer to Dimensions on page 10.]

DC 2-Wire Models

Appearance	Sensing distance			Model	
				Operation mode	
				NO	NC
Unshielded 	17 × 17	5 mm		TL-Q5MD1 2M *1 *2	TL-Q5MD2 2M *1
	25 × 25	7 mm		TL-N7MD1 2M *1	TL-N7MD2 2M *1
	30 × 30	12 mm		TL-N12MD1 2M *1	TL-N12MD2 2M *1
	40 × 40	20 mm		TL-N20MD1 2M *1	TL-N20MD2 2M *1

*1. Models with a different frequency are available to prevent mutual interference. The model numbers are TL-N□MD□5 and TL-Q5MD□5 (e.g., TL-N7MD15).
 *2. Models are also available with robotics (bend resistant) cables. Add "-R" to the model number. (e.g., TL-Q5MD1-R 2M)

DC 3-Wire and AC 2-Wire Models

Appearance	Sensing distance			Output configuration	Model	
					Operation mode	
					NO	NC
Unshielded 	8 × 9	2 mm		DC 3-wire, NPN	TL-Q2MC1 2M	—
	17 × 17	5 mm			TL-Q5MC1 2M *1 *2	TL-Q5MC2 2M
	25 × 25	5 mm		DC 3-wire, NPN	TL-N5ME1 2M *1 *2	TL-N5ME2 2M *1
				AC 2-wire	TL-N5MY1 2M *1	TL-N5MY2 2M *1
	30 × 30	10 mm		DC 3-wire, NPN	TL-N10ME1 2M *1 *2	TL-N10ME2 2M *1
				AC 2-wire	TL-N10MY1 2M *1	TL-N10MY2 2M *1
	40 × 40	20 mm		DC 3-wire, NPN	TL-N20ME1 2M *1 *2	TL-N20ME2 2M *1
				AC 2-wire	TL-N20MY1 2M *1	TL-N20MY2 2M *1

*1. Models with a different frequency are available to prevent mutual interference. The model numbers are TL-□□M□□5 (e.g., TL-N5ME15).
 *2. Models are also available with robotics (bend resistant) cables. Add "-R" to the model number. (e.g., TL-Q5MC1-R 2M)

Accessories (Order Separately)

Mounting Brackets A Mounting Bracket is provided with the Sensor depending on the model number. Check the column for the applicable Sensor. [Refer to *Dimensions* on page 11.]

Type	Model	Applicable Sensors	
		Provided with these Sensors	Order separately
Mounting Brackets	Y92E-C5	TL-N5ME□, TL-N7MD□	TL-N5MY□
	Y92E-C10	TL-N10ME□, TL-N12MD□	TL-N10MY□
	Y92E-C20	TL-N20ME□, TL-N20MD□	TL-N20MY□
Mounting Brackets for Conduits	Y92E-N5C15	---	TL-N5ME□, TL-N5MY□
	Y92E-N10C15	---	TL-N10ME□, TL-N10MY□

Ratings and Specifications

DC 2-Wire Models

Item	Model	TL-Q5MD□	TL-N7MD□	TL-N12MD□	TL-N20MD□
Sensing distance		5 mm ±10%	7 mm ±10%	12 mm ±10%	20 mm ±10%
Set distance		0 to 4 mm	0 to 5.6 mm	0 to 9.6 mm	0 to 16 mm
Differential travel		10% max. of sensing distance			
Detectable object		Ferrous metal (The sensing distance decreases with non-ferrous metal. Refer to <i>Engineering Data</i> on page 5.)			
Standard sensing object		Iron, 18 × 18 × 1 mm	Iron, 30 × 30 × 1 mm	Iron, 40 × 40 × 1 mm	Iron, 50 × 50 × 1 mm
Response frequency *		500 Hz			300 Hz
Power supply voltage (operating voltage range)		12 to 24 VDC (10 to 30 VDC), ripple (p-p): 10% max.			
Leakage current		0.8 mA max.			
Control output	Load current	3 to 100 mA			
	Residual voltage	3.3 V max. (Load current: 100 mA, Cable length: 2 m)			
Indicators		D1 Models: Operation indicator (red), Setting indicator (green) D2 Models: Operation indicator (red)			
Operation mode (with sensing object approaching)		D1 Models: NO D2 Models: NC Refer to the timing charts under <i>I/O Circuit Diagrams</i> on page 7 for details.			
Protection circuits		Load short-circuit protection, Surge suppressor			
Ambient temperature range		Operating/Storage: -25 to 70°C (with no icing or condensation)			
Ambient humidity range		Operating/Storage: 35% to 95% (with no condensation)			
Temperature influence		±10% max. of sensing distance at 23°C in the temperature range of -25 to 70°C			
Voltage influence		±2.5% max. of sensing distance at rated voltage in the rated voltage ±15% range			
Insulation resistance		50 MΩ min. (at 500 VDC) between current-carrying parts and case			
Dielectric strength		1,000 VAC for 1 min between current-carrying parts and case			
Vibration resistance		Destruction: 10 to 55 Hz, 1.5-mm double amplitude for 2 hours each in X, Y, and Z directions			
Shock resistance		Destruction: 500 m/s ² 3 times each in X, Y, and Z directions	Destruction: 1,000 m/s ² 10 times each in X, Y, and Z directions		
Degree of protection		IEC 60529 IP67, in-house standards: oil-resistant			
Connection method		Pre-wired Models (Standard cable length: 2 m)			
Weight (packed state)		Approx. 85 g	Approx. 165 g	Approx. 235 g	Approx. 330 g
Materials	Case	Heat-resistant ABS			
	Sensing surface				
Accessories		Instruction manual	Mounting Bracket, Mounting phillips screws (M4 × 25), Instruction manual	Mounting Bracket, Mounting phillips screws (M4 × 30), Instruction manual	Mounting Bracket, Mounting phillips screws (M5 × 40), Instruction manual

* The response frequency is an average value.

Measurement conditions are as follows: standard sensing object, a distance of twice the standard sensing object, and a set distance of half the sensing distance.

DC 3-Wire Models

Item	Model	TL-Q2MC1	TL-Q5MC□
Sensing distance		2 mm ±15%	5 mm ±10%
Set distance		0 to 1.5 mm	0 to 4 mm
Differential travel		10% max. of sensing distance	
Detectable object		Ferrous metal (The sensing distance decreases with non-ferrous metal. Refer to <i>Engineering Data</i> on page 6.)	
Standard sensing object		Iron, 8 × 8 × 1 mm	Iron, 15 × 15 × 1 mm
Response time		---	2 ms max.
Response frequency *		500 Hz	
Power supply voltage (operating voltage range)		12 to 24 VDC (10 to 30 VDC), ripple (p-p): 10% max.	
Current consumption		15 mA max. at 24 VDC (no-load)	10 mA max. at 24 VDC
Control output	Load current	NPN open collector 100 mA max. at 30 VDC max.	NPN open collector 50 mA max. at 30 VDC max.
	Residual voltage	1 V max. (under load current of 100 mA with cable length of 2 m)	1 V max. (under load current of 50 mA with cable length of 2 m)
Indicators		Detection indicator (red)	
Operation mode (with sensing object approaching)		NO	C1 Models: NO C2 Models: NC
		Refer to the timing charts under <i>DC 3-Wire Models</i> on page 8 for details.	
Protection circuits		Reverse polarity protection, Surge suppressor	
Ambient temperature range		Operating/Storage: -10 to 60°C (with no icing or condensation)	Operating/Storage: -25 to 70°C (with no icing or condensation)
Ambient humidity range		Operating/Storage: 35% to 95% (with no condensation)	
Temperature influence		±10% max. of sensing distance at 23°C in the temperature range of -10 to 60°C	±20% max. of sensing distance at 23°C in the temperature range of -25 to 70°C
Voltage influence		±2.5% max. of sensing distance at rated voltage in rated voltage ±10% range	
Insulation resistance		50 MΩ min. (at 500 VDC) between current-carrying parts and case	5 MΩ min. (at 500 VDC) between current-carrying parts and case
Dielectric strength		1,000 VAC for 1 min between current-carrying parts and case	500 VAC, 50/60 Hz for 1 min between current-carrying parts and case
Vibration resistance		Destruction: 10 to 55 Hz, 1.5-mm double amplitude for 2 hours each in X, Y, and Z directions	
Shock resistance		Destruction: 1,000 m/s ² 10 times each in X, Y, and Z directions	Destruction: 200 m/s ² 10 times each in X, Y, and Z directions
Degree of protection		IEC 60529 IP67, in-house standards: oil-resistant	IEC IP67
Connection method		Pre-wired Models (Standard cable length: 2 m)	
Weight (packed state)		Approx. 60 g	Approx. 90 g
Materials	Case	Heat-resistant ABS	
	Sensing surface		
Accessories		Instruction manual	---

* The response frequency is an average value. Measurement conditions are as follows: standard sensing object, a distance of twice the standard sensing object, and a set distance of half the sensing distance.

Item	Model	TL-N5ME□, TL-N5MY□	TL-N10ME□, TL-N10MY□	TL-N20ME□, TL-N20MY□
Sensing distance		5 mm ±10%	10 mm ±10%	20 mm ±10%
Set distance		0 to 4 mm	0 to 8 mm	0 to 16 mm
Differential travel		15% max. of sensing distance		
Detectable object		Ferrous metal (The sensing distance decreases with non-ferrous metal. Refer to <i>Engineering Data</i> on pages 6 and 7.)		
Standard sensing object		Iron, 30 × 30 × 1 mm	Iron, 40 × 40 × 1 mm	Iron, 50 × 50 × 1 mm
Response frequency *1		E Models: 500 Hz Y Models: 10 Hz		E Models: 40 Hz Y Models: 10 Hz
Power supply voltage *2 (operating voltage range)		E Models: 12 to 24 VDC (10 to 30 VDC), ripple (p-p): 10% max. Y Models: 100 to 220 VAC (90 to 250 VAC), 50/60 Hz		
Current consumption		E Models: 8 mA max. at 12 VDC, 15 mA max. at 24 VDC		
Leakage current		Y Models: Refer to <i>Engineering Data</i> on page 5.		
Control output	Load current	E Models: 100 mA max. at 12 VDC, 200 mA max. at 24 VDC Y Models: 10 to 200 mA		
	Residual voltage	E Models: 1 V max. (load current: 200 mA) Y Models: Refer to <i>Engineering Data</i> on page 5.		
Indicators		E Models: Detection indicator (red) Y Models: Operation indicator (red)		
Operation mode (with sensing object approaching)		E1/Y1 Models: NO E2/Y2 Models: NC Refer to the timing charts under <i>I/O Circuit Diagrams</i> on page 8 for details.		
Protection circuits		E Models: Reverse polarity protection, Surge suppressor Y Models: Surge suppressor		
Ambient temperature range		Operating/Storage: -25 to 70°C (with no icing or condensation)		
Ambient humidity range		Operating/Storage: 35% to 95% (with no condensation)		
Temperature influence		±10% max. of sensing distance at 23°C in the temperature range of -25 to 70°C		
Voltage influence		E Models: ±2.5% max. of sensing distance at rated voltage in rated voltage ±10% range Y Models: ±1% max. of sensing distance at rated voltage in rated voltage ±10% range		
Insulation resistance		50 MΩ min. (at 500 VDC) between current-carrying parts and case		
Dielectric strength		E Models: 1,000 VAC, 50/60 Hz for 1 min between current-carrying parts and case Y Models: 2,000 VAC, 50/60 Hz for 1 min between current-carrying parts and case		
Vibration resistance		Destruction: 10 to 55 Hz, 1.5-mm double amplitude for 2 hours each in X, Y, and Z directions		
Shock resistance		Destruction: 500 m/s ² 10 times each in X, Y, and Z directions		
Degree of protection		IEC 60529 IP67, in-house standards: oil-resistant		
Connection method		Pre-wired Models (Standard cable length: 2 m)		
Weight (packed state)		Approx. 190 g	Approx. 240 g	Approx. 340 g
Materials	Case	Heat-resistant ABS		
	Sensing surface			
Accessories		E Models: Mounting Bracket, Mounting phillips screws (M4 × 25), Instruction manual Y Models: Instruction manual	E Models: Mounting Bracket, Mounting phillips screws (M4 × 30), Instruction manual Y Models: Instruction manual	E Models: Mounting Bracket, Mounting phillips screws (M5 × 40), Instruction manual Y Models: Instruction manual

*1. The response frequency is an average value. Measurement conditions are as follows: standard sensing object, a distance of twice the standard sensing object, and a set distance of half the sensing distance.

*2. E Models (DC switching models): A full-wave rectification power supply of 24 VDC ±10% (average value) can be used.

Engineering Data (Reference Value)

Sensing Area

TL-Q2MC1

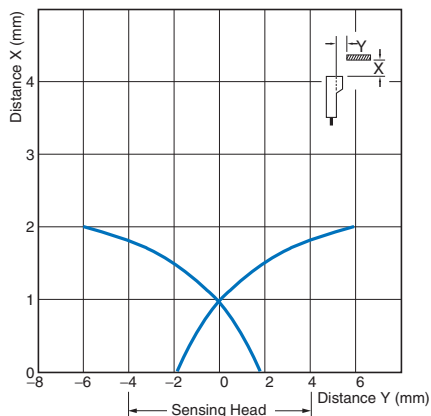

TL-Q5M□□

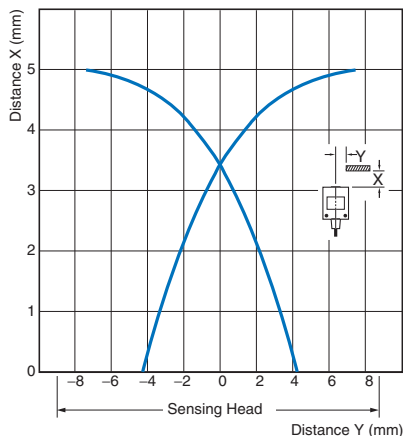

TL-N□ME□
TL-N□MY□

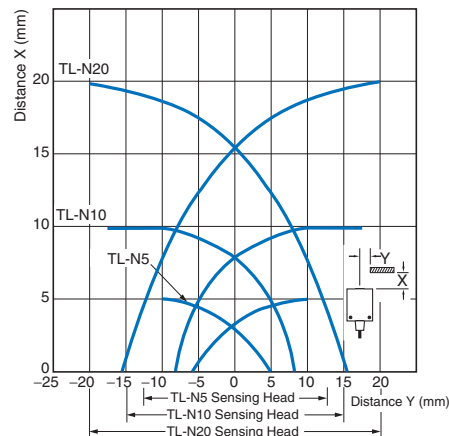

TL-N□MD□

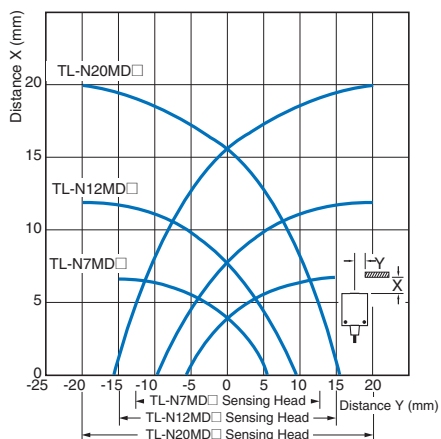

Leakage Current

TL-N□MY

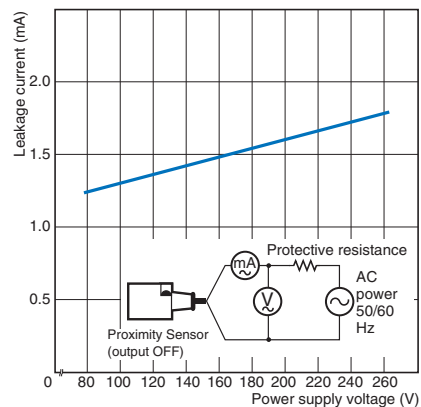

Residual Output Voltage

TL-N□MD

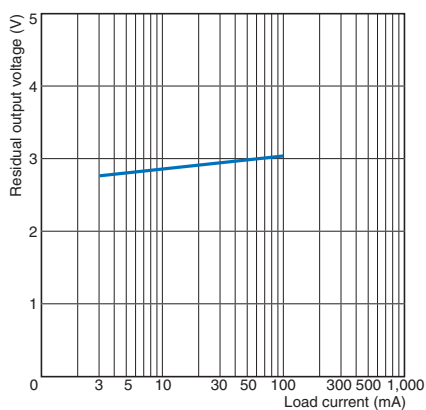

TL-N□MY at 100 VAC

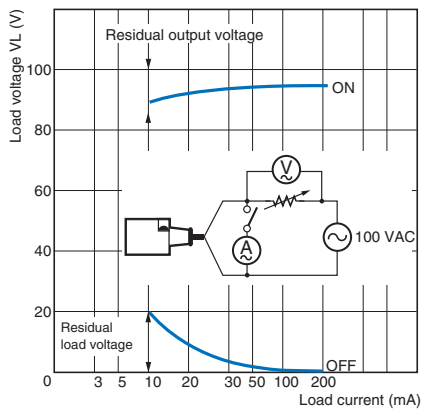

TL-N□MY at 200 VAC

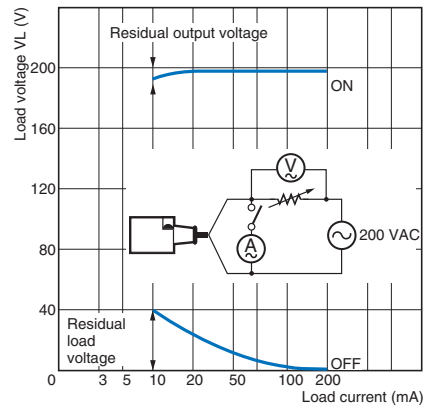

Sensing Object Size vs. Sensing Distance

TL-Q5MC□

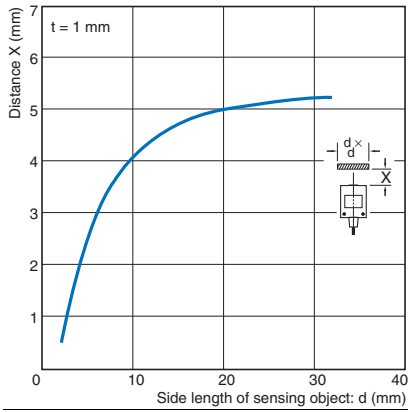

Influence of Sensing Object Size and Material

TL-Q2MC1

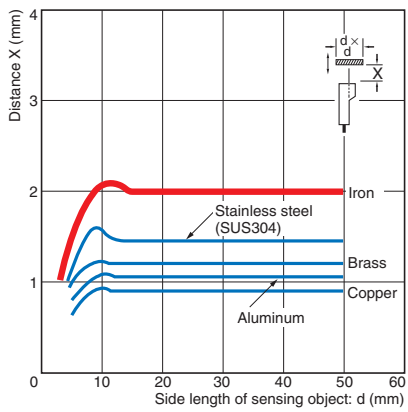

TL-Q5M□□

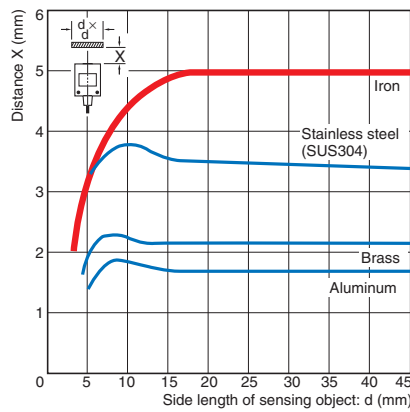

TL-N5□

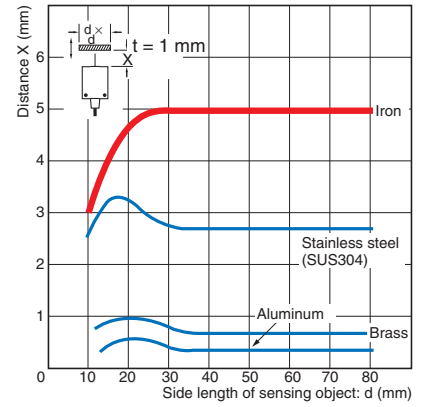

TL-N7MD□

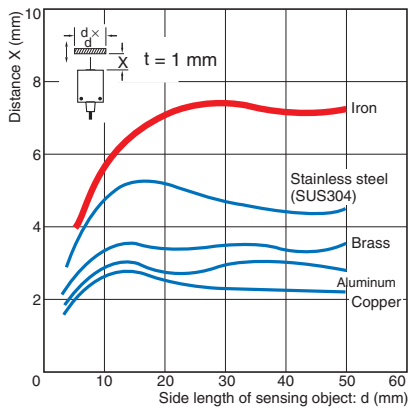

TL-N12MD□

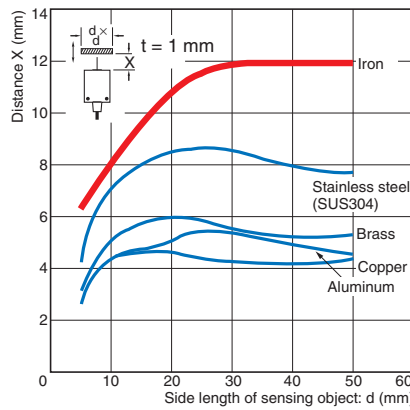

TL-N20MD□

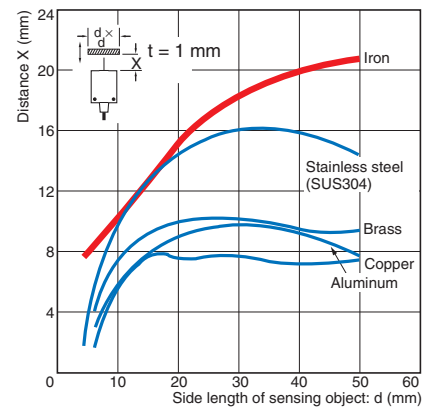

TL-N10□

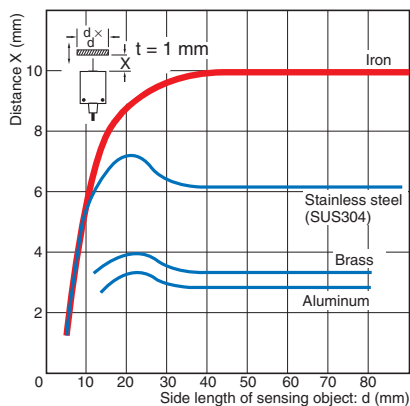

TL-N20□

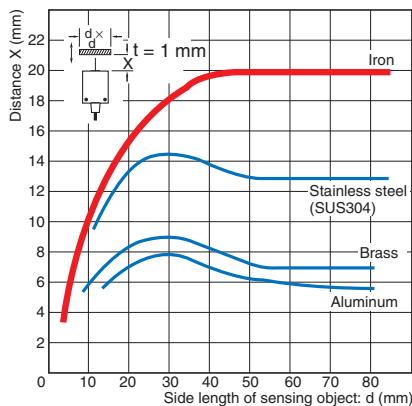

I/O Circuit Diagrams

DC 2-Wire Models

Operation mode	Model	Timing chart	Output circuit
NO	TL-Q5MD1 TL-N7MD1 TL-N12MD1 TL-N20MD1		<p>Note: The load can be connected to either the +V or 0 V side.</p>
NC	TL-Q5MD2 TL-N7MD2 TL-N12MD2 TL-N20MD2		

DC 3-Wire Models

Operation mode	Model	Timing chart	Output circuit
NO	TL-Q2MC1 TL-Q5MC1	<p>Sensing object</p> <p>Present </p> <p>Not present</p> <p>Output transistor (load)</p> <p>ON </p> <p>OFF</p> <p>Detection indicator (red)</p> <p>ON </p> <p>OFF</p>	<p>* Load current: 100 mA max., TL-Q2MC1 Load current: 50 mA max., TL-Q5MC1</p>
NC	TL-Q5MC2	<p>Sensing object</p> <p>Present </p> <p>Not present</p> <p>Output transistor (load)</p> <p>ON </p> <p>OFF</p> <p>Detection indicator (red)</p> <p>ON </p> <p>OFF</p>	
NO	TL-N5ME1 TL-N10ME1 TL-N20ME1	<p>Sensing object</p> <p>Present </p> <p>Not present</p> <p>Load (between brown and black leads)</p> <p>Operate </p> <p>Reset</p> <p>Output voltage (between black and blue leads)</p> <p>High </p> <p>Low</p> <p>Detection indicator (red)</p> <p>ON </p> <p>OFF</p>	<p>*1. Load current: 200 mA max. *2. When a transistor is connected.</p>
NC	TL-N5ME2 TL-N10ME2 TL-N20ME2	<p>Sensing object</p> <p>Present </p> <p>Not present</p> <p>Load (between brown and black leads)</p> <p>Operate </p> <p>Reset</p> <p>Output voltage (between black and blue leads)</p> <p>High </p> <p>Low</p> <p>Detection indicator (red)</p> <p>ON </p> <p>OFF</p>	

AC 2-Wire Models

Operation mode	Model	Timing chart	Output circuit
NO	TL-N5MY1 TL-N10MY1 TL-N20MY1	<p>Sensing object</p> <p>Present </p> <p>Not present</p> <p>Load</p> <p>Operate </p> <p>Reset</p> <p>Operation indicator (red)</p> <p>ON </p> <p>OFF</p>	
NC	TL-N5MY2 TL-N10MY2 TL-N20MY2	<p>Sensing object</p> <p>Present </p> <p>Not present</p> <p>Load</p> <p>Operate </p> <p>Reset</p> <p>Operation indicator (red)</p> <p>ON </p> <p>OFF</p>	

Safety Precautions

Refer to *Warranty and Limitations of Liability*.

⚠ WARNING

This product is not designed or rated for ensuring safety of persons either directly or indirectly. Do not use it for such purposes.



- Do not short-circuit the load, otherwise the Sensor may be damaged.
 - Do not supply power to the Sensor with no load, otherwise the Sensor may be damaged.
- Applicable Models: AC 2-Wire Models



Precautions for Correct Use

Do not use this product under ambient conditions that exceed the ratings.

● Design

Influence of Surrounding Metal

When mounting the Sensor within a metal panel, ensure that the clearances given in the following table are maintained. Failure to maintain these distances may cause deterioration in the performance of the Sensor.

Rectangular Models TL-N*2

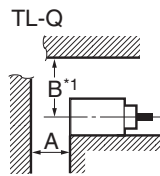
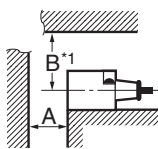

Influence of Surrounding Metal (Unit: mm)

Model	Distance	A	B *1
TL-Q5M□□		20	20
TL-N7MD□		40	35
TL-N12MD□		50	40
TL-N20MD□		70	60
TL-N5ME□, TL-N5MY□		20	23
TL-N10ME□, TL-N10MY□		40	30
TL-N20ME□, TL-N20MY□		80	45

*1. The B dimension applies to the top, right-side, and left-side surfaces.

*2. The values for A or B for the TL-N apply when there is metal on only one side of the sensor. If there is metal on two or more sides of the sensor, the value must be multiplied by two or more.

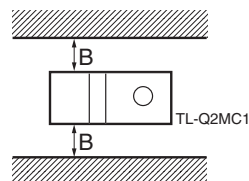
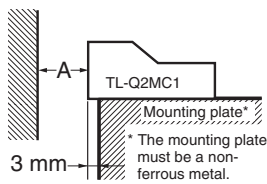

Influence of Surrounding Metal (Unit: mm)

Model	Distance	A	B
TL-Q2MC1		12	3

● Mounting

When tightening the mounting screws, do not exceed the torque in the following table.

Model	Torque
TL-Q2MC1	0.59 N·m
TL-Q5M□□	
TL-N□M□□	0.9 to 1.5 N·m

Mutual Interference

When installing Sensors face-to-face or side-by-side, ensure that the minimum distances given in the following table are maintained.

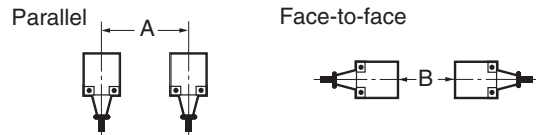

Mutual Interference (Unit: mm)

Model	Distance	A *	B *
TL-Q5MC□		60 (17)	120 (60)
TL-Q5MD□		60 (30)	120 (80)
TL-N7MD□		100 (50)	120 (60)
TL-N12MD□		120 (60)	200 (100)
TL-N20MD□		200 (100)	200 (100)
TL-N5ME□		80 (40)	80 (40)
TL-N5MY□		80 (40)	90 (40)
TL-N10ME□, TL-N10MY□		120 (60)	120 (60)
TL-N20ME□, TL-N20MY□		200 (100)	120 (60)

* Values in parentheses apply to Sensors operating at different frequencies.

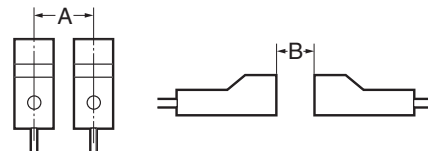

Mutual Interference (Unit: mm)

Model	Distance	A *	B *
TL-Q2MC1		30 (8)	90 (45)

* Values in parentheses apply to Sensors operating at different frequencies.

Dimensions

Sensors

TL-Q2MC1

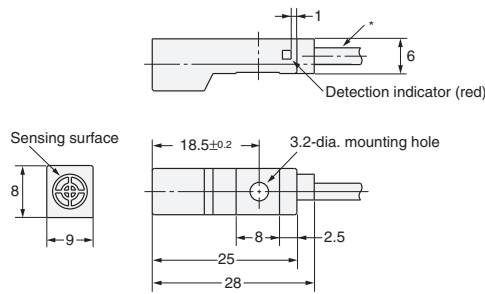
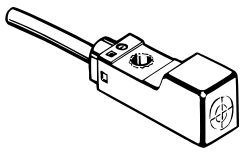

* 2.9-dia. vinyl-insulated round cable with 3 conductors
(Conductor cross section: 0.15 mm², Insulator diameter: 0.9 mm), Standard length: 2 m

TL-Q5M□□

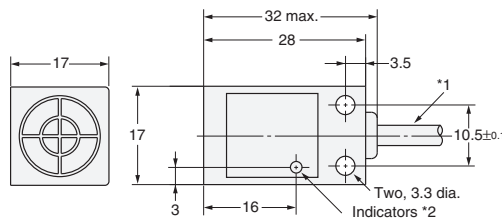
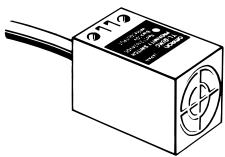

Mounting Hole Dimensions

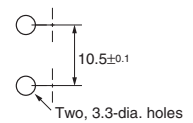

*1. C Models: 4-dia. vinyl-insulated round cable with 3 conductors (Conductor cross section: 0.2 mm², Insulator diameter: 1.2 mm), Standard length: 2 m
D Models: 4-dia. vinyl-insulated round cable with 2 conductors (Conductor cross section: 0.3 mm², Insulator diameter: 1.3 mm), Standard length: 2 m
*2. C Models: Detection indicator (red)
D Models: Operation indicator (red), Setting indicator (green)

TL-N7MD□, TL-N5ME□

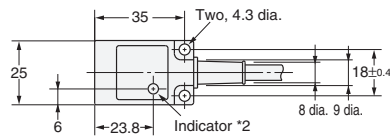
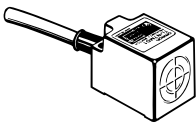

Mounting Hole Dimensions

Two, 4.5-dia. or M4 holes

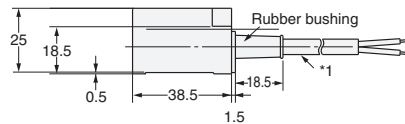
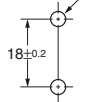

*1. D Models: 6-dia. vinyl-insulated round cable with 2 conductors (Conductor cross section: 0.5 mm², Insulator diameter: 1.9 mm), Standard length: 2 m
E Models: 6-dia. vinyl-insulated round cable with 3 conductors (Conductor cross section: 0.5 mm², Insulator diameter: 1.9 mm), Standard length: 2 m
*2. D1 Models: Operation indicator (red), Setting indicator (green)
D2 Models: Operation indicator (red)
E Models: Detection indicator (red)

TL-N5MY□

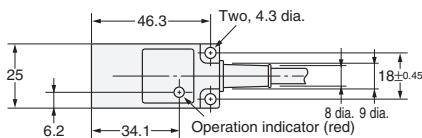
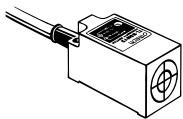

Mounting Hole Dimensions

Two, 4.5-dia. or M4 holes

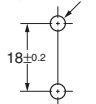

* 6-dia. vinyl-insulated round cable with 2 conductors
(Conductor cross section: 0.5 mm², Insulator diameter: 1.9 mm), Standard length: 2 m

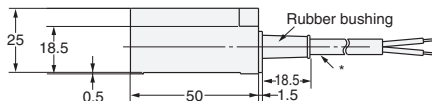

TL-N12MD□,
TL-N10ME□,
TL-N10MY□

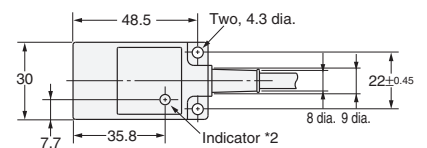
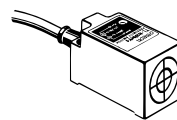

Mounting Hole Dimensions

Two, 4.5-dia. or M4 holes

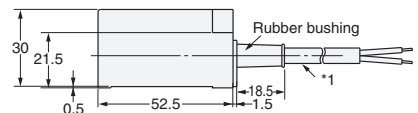
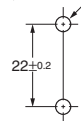

*1. D/Y Models: 6-dia. vinyl-insulated round cable with 2 conductors
(Conductor cross section: 0.5 mm², Insulator diameter: 1.9 mm), Standard length: 2 m
E Models: 6-dia. vinyl-insulated round cable with 3 conductors
(Conductor cross section: 0.5 mm², Insulator diameter: 1.9 mm), Standard length: 2 m
*2. D1 Models: Operation indicator (red) and Setting indicator (green)
D2 Models: Operation indicator (red)
E Models: Detection indicator (red)
Y Models: Operation indicator (red)

TL-N20MD□, TL-N20ME□, TL-N20MY□

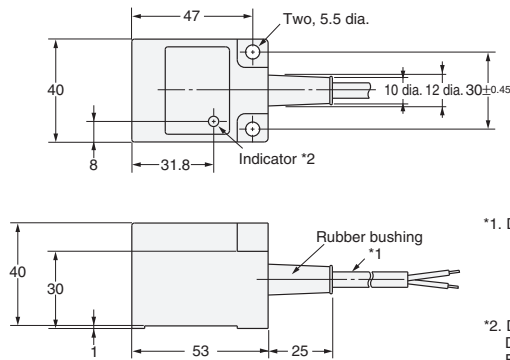
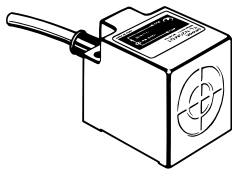

Mounting Hole Dimensions

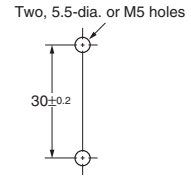

- *1. D/Y Models: 6-dia. vinyl-insulated round cable with 2 conductors (Conductor cross section: 0.5 mm², Insulator diameter: 1.9 mm), Standard length: 2 m
E Models: 6-dia. vinyl-insulated round cable with 3 conductors (Conductor cross section: 0.5 mm², Insulator diameter: 1.9 mm), Standard length: 2 m
- *2. D1 Models: Operation indicator (red) and Setting indicator (green)
D2 Models: Operation indicator (red)
E Models: Detection indicator (red)
Y Models: Operation indicator (red)

Accessories (Order Separately)

Mounting Bracket

Y92E-C5

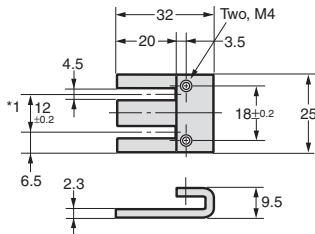

Applicable Models: TL-N5ME□ *2
Applicable Models: TL-N5MY□
Applicable Models: TL-N7MD□ *2
Material: Mounting Bracket: Zinc-plated iron
Mounting phillips Screws: Nickel-plated iron

Y92E-C10

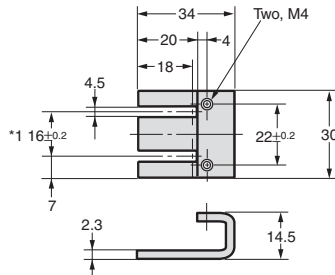

Applicable Models: TL-N10ME□ *2
Applicable Models: TL-N10MY□
Applicable Models: TL-N12MD□ *2
Material: Mounting Bracket: Zinc-plated iron
Mounting phillips Screws: Nickel-plated iron

Y92E-C20

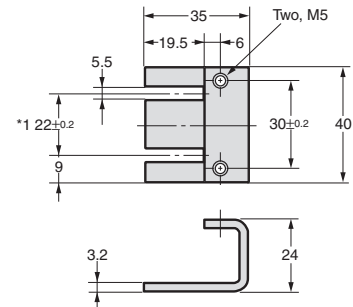

Applicable Models: TL-N20ME□ *2
Applicable Models: TL-N20MY□
Applicable Models: TL-N20MD□ *2
Material: Mounting Bracket: Zinc-plated iron
Mounting phillips Screws: Nickel-plated iron

*1. These are the mounting dimensions of the base of the Mounting Bracket.
*2. Provided with the product.

Mounting Brackets for Wiring Conduit Use (Sold Separately)

Y92E-N5C15

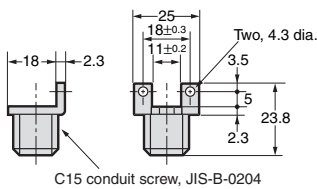

Applicable Models: TL-N5ME□
Applicable Models: TL-N5MY□
Applicable Models: TL-N7MD□
Material: Zinc-plated iron

Y92E-N10C15

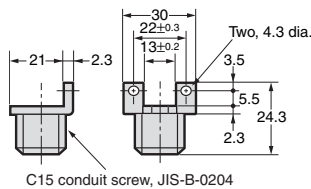

Applicable Models: TL-N10ME□
Applicable Models: TL-N10MY□
Applicable Models: TL-N12MD□
Material: Zinc-plated iron

Terms and Conditions Agreement

Read and understand this catalog.

Please read and understand this catalog before purchasing the products. Please consult your OMRON representative if you have any questions or comments.

Warranties.

(a) Exclusive Warranty. Omron's exclusive warranty is that the Products will be free from defects in materials and workmanship for a period of twelve months from the date of sale by Omron (or such other period expressed in writing by Omron). Omron disclaims all other warranties, express or implied.

(b) Limitations. OMRON MAKES NO WARRANTY OR REPRESENTATION, EXPRESS OR IMPLIED, ABOUT NON-INFRINGEMENT, MERCHANTABILITY OR FITNESS FOR A PARTICULAR PURPOSE OF THE PRODUCTS. BUYER ACKNOWLEDGES THAT IT ALONE HAS DETERMINED THAT THE PRODUCTS WILL SUITABLY MEET THE REQUIREMENTS OF THEIR INTENDED USE.

Omron further disclaims all warranties and responsibility of any type for claims or expenses based on infringement by the Products or otherwise of any intellectual property right. (c) Buyer Remedy. Omron's sole obligation hereunder shall be, at Omron's election, to (i) replace (in the form originally shipped with Buyer responsible for labor charges for removal or replacement thereof) the non-complying Product, (ii) repair the non-complying Product, or (iii) repay or credit Buyer an amount equal to the purchase price of the non-complying Product; provided that in no event shall Omron be responsible for warranty, repair, indemnity or any other claims or expenses regarding the Products unless Omron's analysis confirms that the Products were properly handled, stored, installed and maintained and not subject to contamination, abuse, misuse or inappropriate modification. Return of any Products by Buyer must be approved in writing by Omron before shipment. Omron Companies shall not be liable for the suitability or unsuitability or the results from the use of Products in combination with any electrical or electronic components, circuits, system assemblies or any other materials or substances or environments. Any advice, recommendations or information given orally or in writing, are not to be construed as an amendment or addition to the above warranty.

See <http://www.omron.com/global/> or contact your Omron representative for published information.

Limitation on Liability; Etc.

OMRON COMPANIES SHALL NOT BE LIABLE FOR SPECIAL, INDIRECT, INCIDENTAL, OR CONSEQUENTIAL DAMAGES, LOSS OF PROFITS OR PRODUCTION OR COMMERCIAL LOSS IN ANY WAY CONNECTED WITH THE PRODUCTS, WHETHER SUCH CLAIM IS BASED IN CONTRACT, WARRANTY, NEGLIGENCE OR STRICT LIABILITY.

Further, in no event shall liability of Omron Companies exceed the individual price of the Product on which liability is asserted.

Suitability of Use.

Omron Companies shall not be responsible for conformity with any standards, codes or regulations which apply to the combination of the Product in the Buyer's application or use of the Product. At Buyer's request, Omron will provide applicable third party certification documents identifying ratings and limitations of use which apply to the Product. This information by itself is not sufficient for a complete determination of the suitability of the Product in combination with the end product, machine, system, or other application or use. Buyer shall be solely responsible for determining appropriateness of the particular Product with respect to Buyer's application, product or system. Buyer shall take application responsibility in all cases.

NEVER USE THE PRODUCT FOR AN APPLICATION INVOLVING SERIOUS RISK TO LIFE OR PROPERTY OR IN LARGE QUANTITIES WITHOUT ENSURING THAT THE SYSTEM AS A WHOLE HAS BEEN DESIGNED TO ADDRESS THE RISKS, AND THAT THE OMRON PRODUCT(S) IS PROPERLY RATED AND INSTALLED FOR THE INTENDED USE WITHIN THE OVERALL EQUIPMENT OR SYSTEM.

Programmable Products.

Omron Companies shall not be responsible for the user's programming of a programmable Product, or any consequence thereof.

Performance Data.

Data presented in Omron Company websites, catalogs and other materials is provided as a guide for the user in determining suitability and does not constitute a warranty. It may represent the result of Omron's test conditions, and the user must correlate it to actual application requirements. Actual performance is subject to the Omron's Warranty and Limitations of Liability.

Change in Specifications.

Product specifications and accessories may be changed at any time based on improvements and other reasons. It is our practice to change part numbers when published ratings or features are changed, or when significant construction changes are made. However, some specifications of the Product may be changed without any notice. When in doubt, special part numbers may be assigned to fix or establish key specifications for your application. Please consult with your Omron's representative at any time to confirm actual specifications of purchased Product.

Errors and Omissions.

Information presented by Omron Companies has been checked and is believed to be accurate; however, no responsibility is assumed for clerical, typographical or proofreading errors or omissions.